

D-NAMIC

92 Shore A
+90°C
-40°C

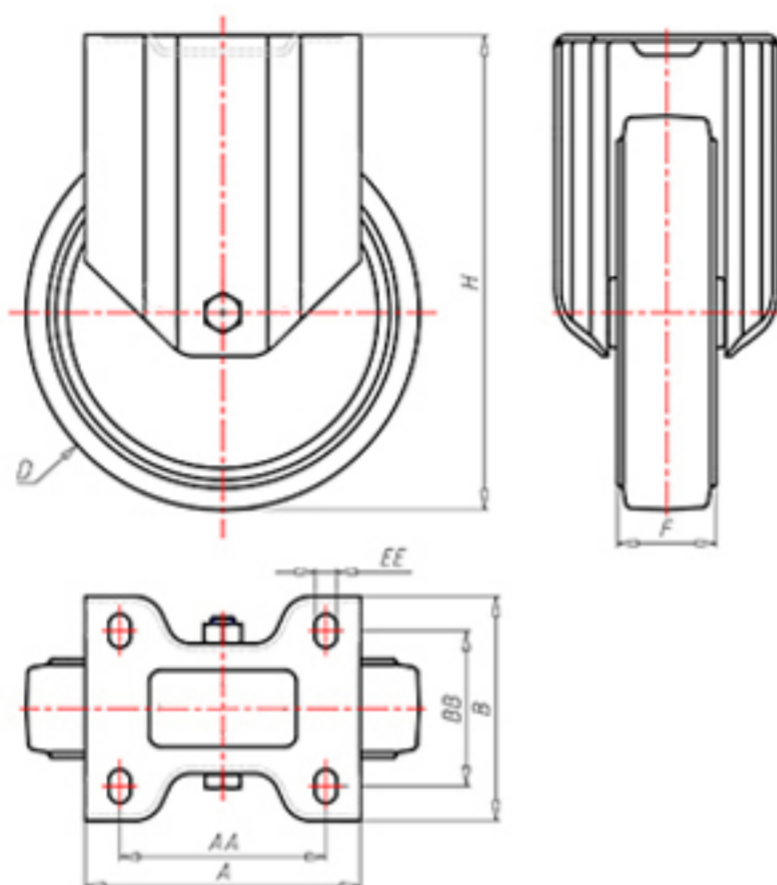

	D	125
	F	35
	H	155
	AxB	100x85
	AAxBB	80x60
	EE	9
	LC	260



Code for plain bore wheel

XNFZ12545



Code for wheel with roller bearing

XNFZ12545R



Code for wheel with double sealed ball bearing

XNFZ125C



Code for wheel with double sealed Inox ball bearing

-

