

**DITHERM
STW**

+280°C
-70°C

INOX

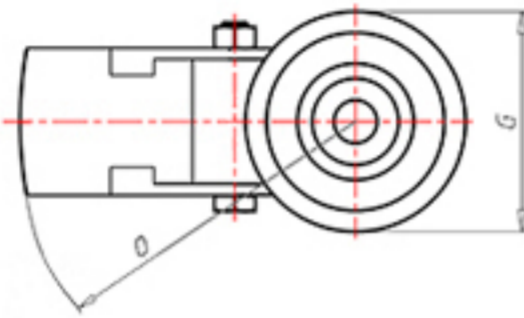
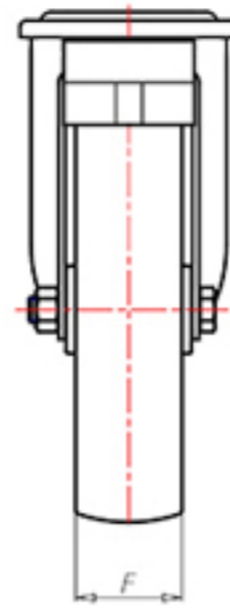
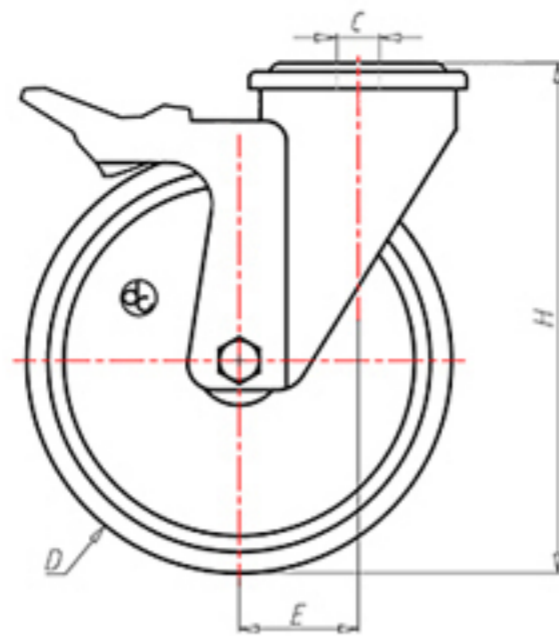

	D	150
	F	40
	H	181
	G	Ø 102
	C	Ø 16
	E	52
	O	124
	Kg LC	350



Code for plain bore wheel

SPX15060FA



Code for wheel with coated bush

-



Code for wheel with double BT self-lube bush

-



Code for wheel with double HT ball bearing

-

