

**DITHERM
STW**

+280°C
-70°C

INOX

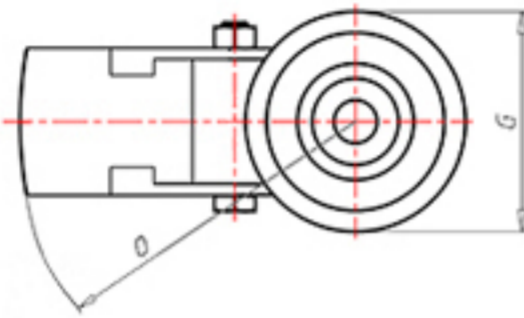
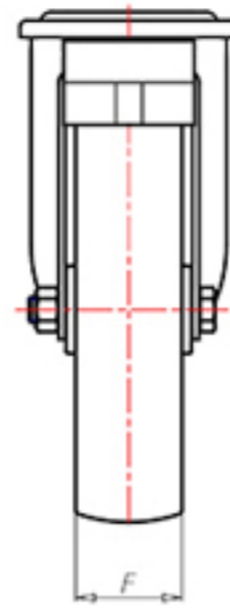
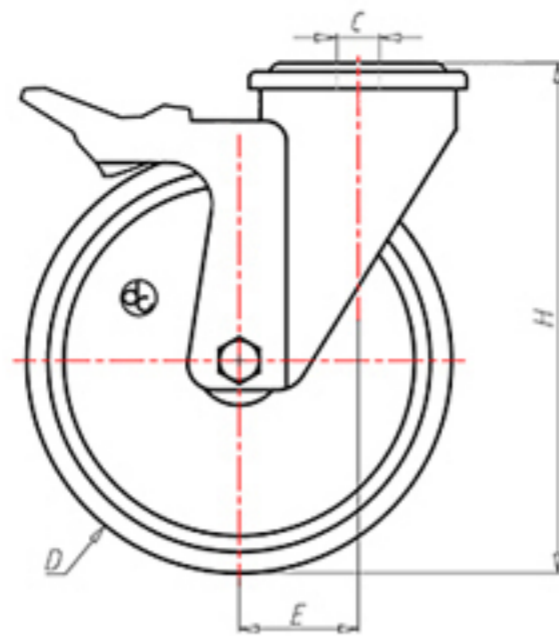

	D	125
	F	30
	H	155
	G	Ø 77
	C	Ø 12
	E	44
	O	124
	LC	230



Code for plain bore wheel

SPX12545FA



Code for wheel with coated bush

SPX12545BRFA



Code for wheel with double BT self-lube bush

-



Code for wheel with double HT ball bearing

-

