

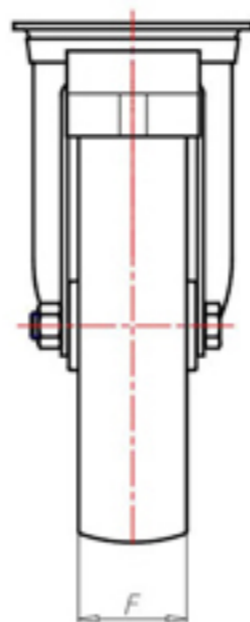

+260°C
-40°C

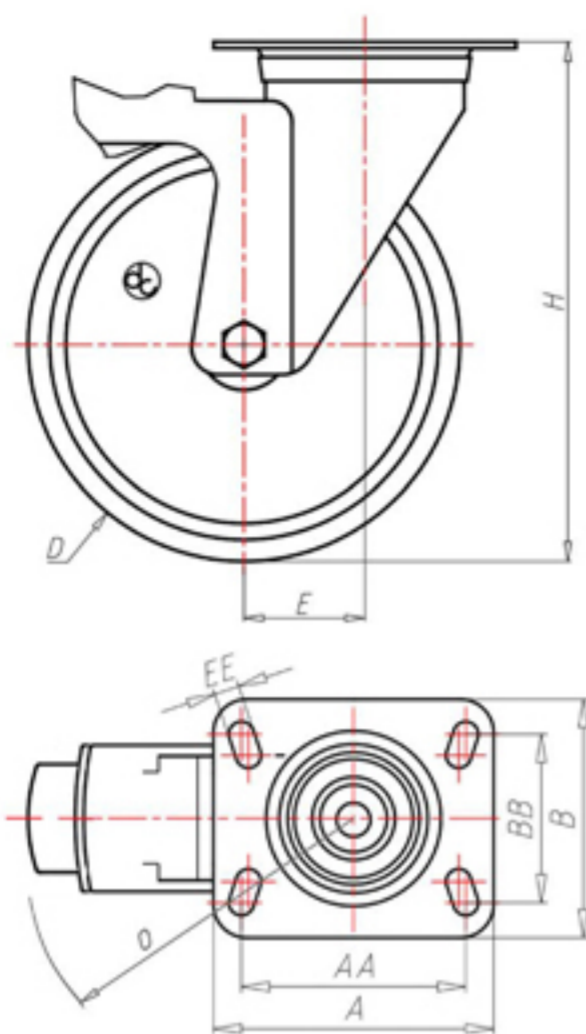

	D	80
	F	30
	H	128
	AxB	100x85
	AAxBB	80x60
	EE	9
	E	42
	O	124
	LC	120



Code for plain bore wheel

RGZ80FS



Code for wheel with coated bush

RGZ80BRFS



Code for wheel with double BT self-lube bush

RGZ80BTFS



Code for wheel with double HT ball bearing

RGZ80CFS

